

# THERMOSTATIC MATTE BLACK RECESSED CEILING MOUNT LED RAINFALL SHOWER SYSTEM WITH SOUND SYSTEM AND HAND SHOWER SPECIFICATIONS

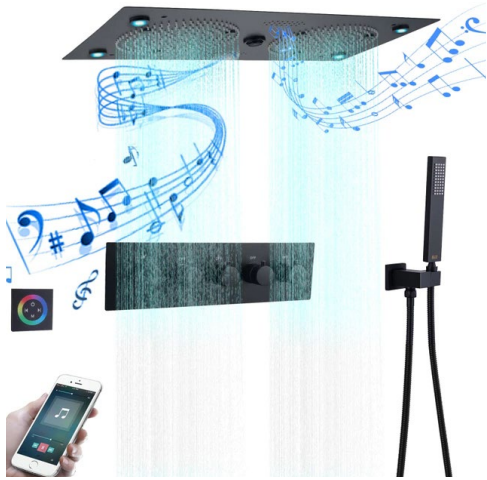

**Shower Head**

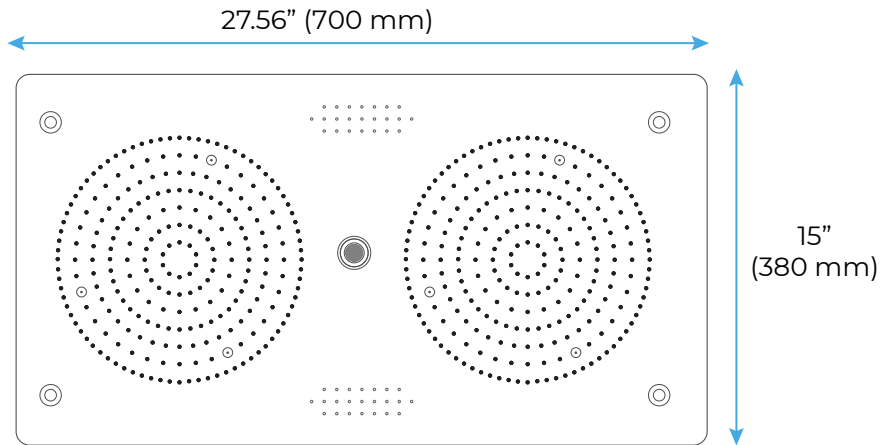

- Shower Head Functions: Rainfall, Bubble, Mist
- Shower Panel /Hose Material: 304 Stainless Steel
- Showerheads Install: Embedded Ceiling Mounted
- Concealed Mixer Install: Wall-Mounted
- Shower Accessories Material: Brass
- LED Light: Need to Connect Power
- Shower Hose Length: 1.5M
- Power: 100V~240V Alternating Current (AC)
- LED Colors: 7 Colors
- Water Flow: 16L/min~28L/min
- Music: Need Bluetooth

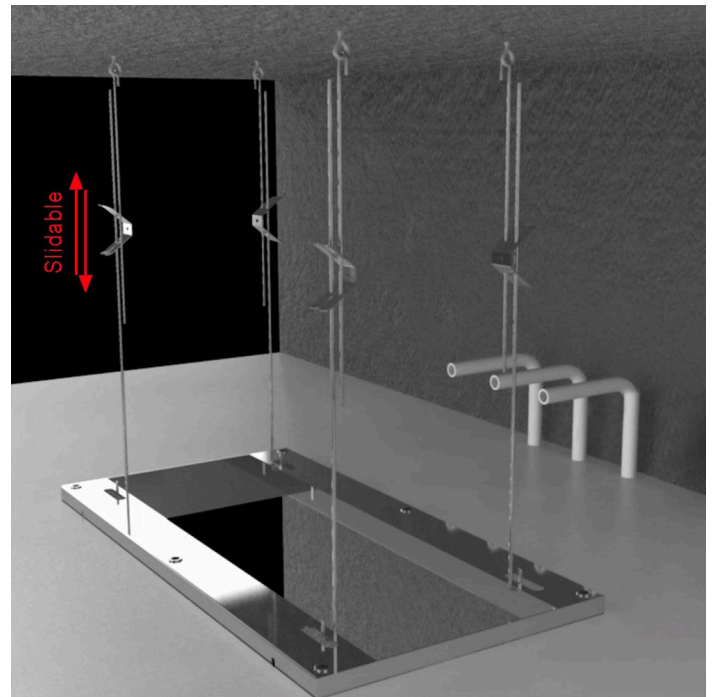

Product shown is only for installation display purpose

## Touch Panel Control

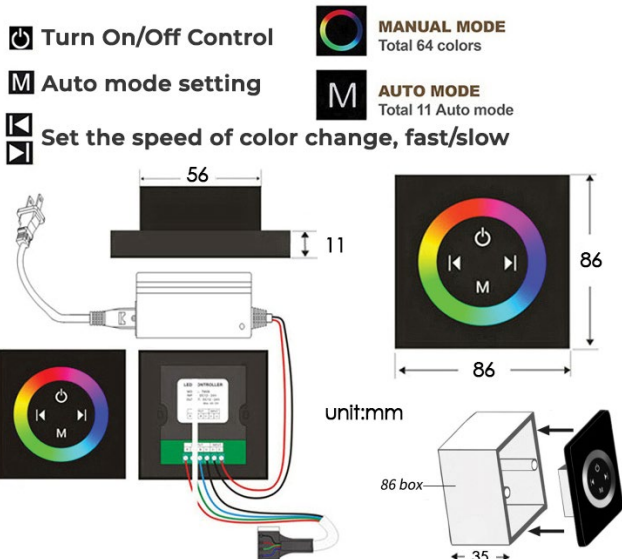

All dimensions and specifications are nominal and may vary. Use actual products for accuracy in critical situations.

**Shower Mixer**

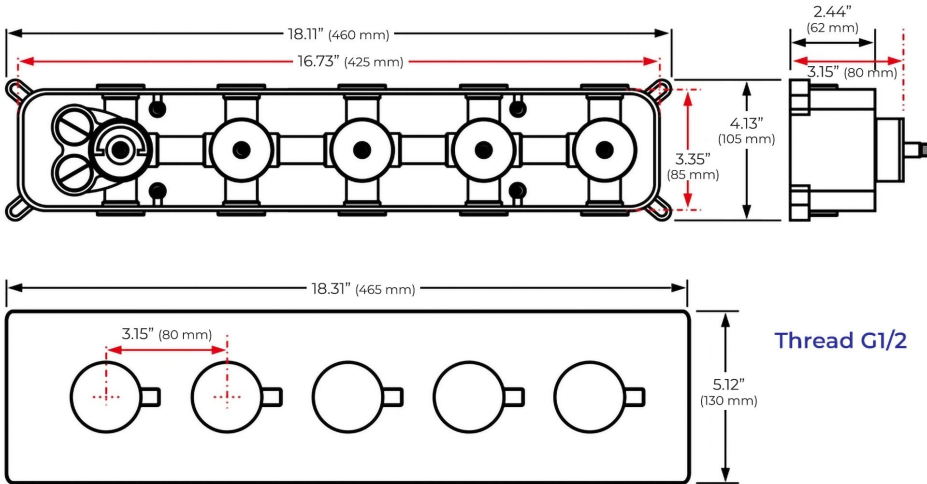

All Function can be used at the same time.

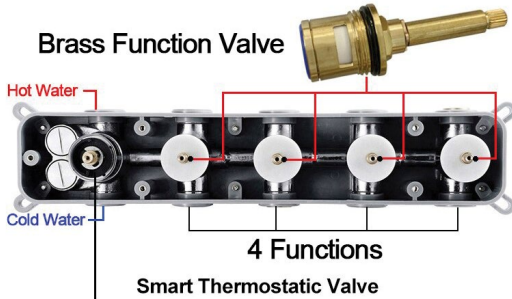

**Hand Shower**

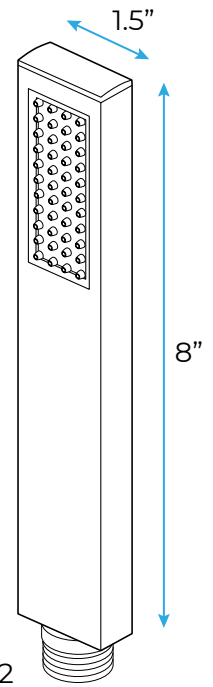

Flow Rate: 2.0 GPM / 7.6 LPM

**Shower Mixer Connections**

